

LM340/LM78XX Series

3-Terminal Positive Regulators

General Description

The LM140/LM340A/LM340/LM78XXC monolithic 3-terminal positive voltage regulators employ internal current-limiting, thermal shutdown and safe-area compensation, making them essentially indestructible. If adequate heat sinking is provided, they can deliver over 1.0A output current. They are intended as fixed voltage regulators in a wide range of applications including local (on-card) regulation for elimination of noise and distribution problems associated with single-point regulation. In addition to use as fixed voltage regulators, these devices can be used with external components to obtain adjustable output voltages and currents.

Considerable effort was expended to make the entire series of regulators easy to use and minimize the number of external components. It is not necessary to bypass the output, although this does improve transient response. Input bypassing is needed only if the regulator is located far from the filter capacitor of the power supply.

The 5V, 12V, and 15V regulator options are available in the steel TO-3 power package. The LM340A/LM340/LM78XXC series is available in the TO-220 plastic power package, and the LM340-5.0 is available in the SOT-223 package, as well as the LM340-5.0 and LM340-12 in the surface-mount TO-263 package.

Features

- Complete specifications at 1A load
- Output voltage tolerances of $\pm 2\%$ at $T_j = 25^\circ\text{C}$ and $\pm 4\%$ over the temperature range (LM340A)
- Line regulation of 0.01% of V_{OUT}/V of ΔV_{IN} at 1A load (LM340A)
- Load regulation of 0.3% of V_{OUT}/A (LM340A)
- Internal thermal overload protection
- Internal short-circuit current limit
- Output transistor safe area protection
- P+ Product Enhancement tested

Typical Applications

Fixed Output Regulator

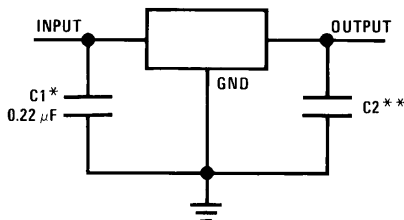

00778101

*Required if the regulator is located far from the power supply filter.

**Although no output capacitor is needed for stability, it does help transient response. (If needed, use 0.1 μF , ceramic disc).

Adjustable Output Regulator

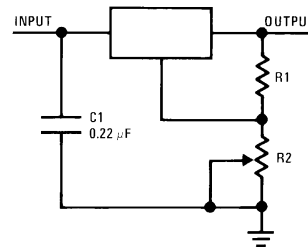

00778102

$$V_{OUT} = 5V + (5V/R1 + I_Q) R2 \quad 5V/R1 > 3 I_Q$$

$$\text{load regulation } (L_r) \approx [(R1 + R2)/R1] \quad (L_r \text{ of LM340-5}).$$

Current Regulator

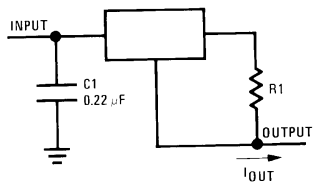

00778103

$$I_{OUT} = \frac{V_{2-3}}{R1} + I_Q$$

$\Delta I_Q = 1.3 \text{ mA}$ over line and load changes.

Comparison between SOT-223 and D-Pak (TO-252) Packages

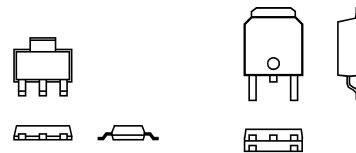

SOT-223

TO-252

00778138

Scale 1:1

Ordering Information

Package	Temperature Range	Part Number	Packaging Marking	Transport Media	NSC Drawing
3-Lead TO-3	-55°C to +125°C	LM140K-5.0	LM140K 5.0P+	50 Per Tray	K02A
		LM140K-12	LM140K 12P+	50 Per Tray	
		LM140K-15	LM140K 15P+	50 Per Tray	
	0°C to +125°C	LM340K-5.0	LM340K 5.0 7805P+	50 Per Tray	
		LM340K-12	LM340K 12 7812P+	50 Per Tray	
		LM340K-15	LM340K 15 7815P+	50 Per Tray	
3-lead TO-220	0°C to +125°C	LM340AT-5.0	LM340AT 5.0 P+	45 Units/Rail	T03B
		LM340T-5.0	LM340T5 7805 P+	45 Units/Rail	
		LM340T-12	LM340T12 7812 P+	45 Units/Rail	
		LM340T-15	LM340T15 7815 P+	45 Units/Rail	
		LM7808CT	LM7808CT	45 Units/Rail	
3-Lead TO-263	0°C to +125°C	LM340S-5.0	LM340S-5.0 P+	45 Units/Rail	TS3B
		LM340SX-5.0		500 Units Tape and Reel	
		LM340S-12	LM340S-12 P+	45 Units/Rail	
		LM340SX-12		500 Units Tape and Reel	
		LM340AS-5.0	LM340AS-5.0 P+	45 Units/Rail	
		LM340ASX-5.0		500 Units Tape and Reel	
4-Lead SOT-223	0°C to +125°C	LM340MP-5.0	N00A	1k Units Tape and Reel	MP04A
		LM340MPX-5.0		2k Units Tape and Reel	
Unpackaged Die	-55°C to 125°C	LM140KG-5 MD8		Waffle Pack or Gel Pack	DL069089
		LM140KG-12 MD8		Waffle Pack or Gel Pack	DL059093
		LM140KG-15 MD8		Waffle Pack or Gel Pack	DL059093
	0°C to +125°C	LM340-5.0 MDA		Waffle Pack or Gel Pack	DI074056
		LM7808C MDC		Waffle Pack or Gel Pack	DI074056

Connection Diagrams

TO-3 Metal Can Package (K)

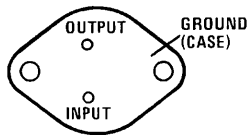

00778111

Bottom View
See Package Number K02A

TO-220 Power Package (T)

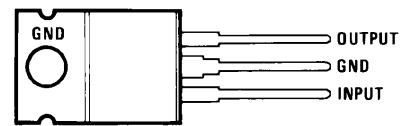

00778112

Top View
See Package Number T03B

TO-263 Surface-Mount Package (S)

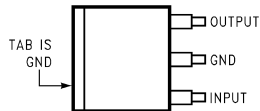

00778120

Top View
See Package Number TS3B

3-Lead SOT-223

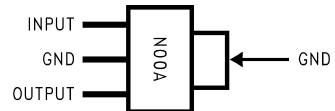

00778143

Top View
See Package Number MP04A

Absolute Maximum Ratings (Note 1)

If Military/Aerospace specified devices are required, please contact the National Semiconductor Sales Office/Distributors for availability and specifications.

(Note 5)

DC Input Voltage	35V
Internal Power Dissipation (Note 2)	Internally Limited
Maximum Junction Temperature	150°C
Storage Temperature Range	-65°C to +150°C
Lead Temperature (Soldering, 10 sec.)	
TO-3 Package (K)	300°C

TO-220 Package (T), TO-263

Package (S)

230°C

ESD Susceptibility (Note 3)

2 kV

Operating Conditions (Note 1)Temperature Range (T_A) (Note 2)

LM140	-55°C to +125°C
LM340A, LM340	0°C to +125°C
LM7808C	0°C to +125°C

LM340A Electrical Characteristics $I_{OUT} = 1A$, $0^\circ C \leq T_J \leq +125^\circ C$ (LM340A) unless otherwise specified (Note 4)

Symbol	Output Voltage		5V			12V			15V			Units	
	Input Voltage (unless otherwise noted)		10V			19V			23V				
	Parameter	Conditions	Min	Typ	Max	Min	Typ	Max	Min	Typ	Max		
V_O	Output Voltage	$T_J = 25^\circ C$	4.9	5	5.1	11.75	12	12.25	14.7	15	15.3	V	
		$P_D \leq 15W$, $5 mA \leq I_O \leq 1A$	4.8		5.2	11.5		12.5	14.4		15.6	V	
		$V_{MIN} \leq V_{IN} \leq V_{MAX}$	(7.5 $\leq V_{IN} \leq 20$)			(14.8 $\leq V_{IN} \leq 27$)			(17.9 $\leq V_{IN} \leq 30$)			V	
ΔV_O	Line Regulation	$I_O = 500 mA$	10			18			22			mV	
		ΔV_{IN}	(7.5 $\leq V_{IN} \leq 20$)			(14.8 $\leq V_{IN} \leq 27$)			(17.9 $\leq V_{IN} \leq 30$)			V	
		$T_J = 25^\circ C$	3	10		4	18		4	22		mV	
		ΔV_{IN}	(7.5 $\leq V_{IN} \leq 20$)			(14.5 $\leq V_{IN} \leq 27$)			(17.5 $\leq V_{IN} \leq 30$)			V	
		$T_J = 25^\circ C$	4			9			10			mV	
	Over Temperature	12			30			30			mV		
	ΔV_{IN}	(8 $\leq V_{IN} \leq 12$)			(16 $\leq V_{IN} \leq 22$)			(20 $\leq V_{IN} \leq 26$)			V		
ΔV_O	Load Regulation	$T_J = 25^\circ C$	$5 mA \leq I_O \leq 1.5A$	10	25		12	32		12	35	mV	
			$250 mA \leq I_O \leq 750 mA$		15			19			21	mV	
		Over Temperature, $5 mA \leq I_O \leq 1A$		25			60			75	mV		
I_Q	Quiescent Current	$T_J = 25^\circ C$	6			6			6			mA	
		Over Temperature	6.5			6.5			6.5			mA	
ΔI_Q	Quiescent Current Change	$5 mA \leq I_O \leq 1A$		0.5			0.5			0.5			mA
		$T_J = 25^\circ C$, $I_O = 1A$		0.8			0.8			0.8			mA
		$V_{MIN} \leq V_{IN} \leq V_{MAX}$		(7.5 $\leq V_{IN} \leq 20$)			(14.8 $\leq V_{IN} \leq 27$)			(17.9 $\leq V_{IN} \leq 30$)			V
		$I_O = 500 mA$		0.8			0.8			0.8			mA
V_N	Output Noise Voltage	$T_A = 25^\circ C$, $10 Hz \leq f \leq 100 kHz$		40			75			90			μV
		$\frac{\Delta V_{IN}}{\Delta V_{OUT}}$	Ripple Rejection	$T_J = 25^\circ C$, $f = 120 Hz$, $I_O = 1A$		68	80		61	72		60	70
or $f = 120 Hz$, $I_O = 500 mA$,				68			61			60		dB	
Over Temperature, $V_{MIN} \leq V_{IN} \leq V_{MAX}$				(8 $\leq V_{IN} \leq 18$)			(15 $\leq V_{IN} \leq 25$)			(18.5 $\leq V_{IN} \leq 28.5$)			V
R_O	Dropout Voltage	$T_J = 25^\circ C$, $I_O = 1A$		2.0			2.0			2.0			V
		$f = 1 kHz$		8			18			19			m Ω
		$T_J = 25^\circ C$		2.1			1.5			1.2			A
	Output Resistance												
	Short-Circuit Current												

LM140 Electrical Characteristics (Note 4) (Continued)-55°C ≤ T_J ≤ +150°C unless otherwise specified

Symbol	Output Voltage		5V			12V			15V			Units
	Input Voltage (unless otherwise noted)		10V			19V			23V			
	Parameter	Conditions	Min	Typ	Max	Min	Typ	Max	Min	Typ	Max	
$\frac{\Delta V_{IN}}{\Delta V_{OUT}}$	Ripple Rejection	I _O ≤ 1A, T _J = 25°C	68	80		61	72		60	70		dB
		f = 120 Hz I _O ≤ 500 mA, -55°C ≤ T _J ≤ +150°C	68			61			60			dB
		V _{MIN} ≤ V _{IN} ≤ V _{MAX}	(8 ≤ V _{IN} ≤ 18)			(15 ≤ V _{IN} ≤ 25)			(18.5 ≤ V _{IN} ≤ 28.5)			V
R _O	Dropout Voltage	T _J = 25°C, I _O = 1A	2.0			2.0			2.0			V
	Output Resistance	f = 1 kHz	8			18			19			mΩ
	Short-Circuit Current	T _J = 25°C	2.1			1.5			1.2			A
	Peak Output Current	T _J = 25°C	2.4			2.4			2.4			A
	Average TC of V _{OUT}	0°C ≤ T _J ≤ +150°C, I _O = 5 mA	-0.6			-1.5			-1.8			mV/°C
	V _{IN}	Input Voltage Required to Maintain Line Regulation	T _J = 25°C, I _O ≤ 1A	7.5			14.6			17.7		

LM340 Electrical Characteristics (Note 4)0°C ≤ T_J ≤ +125°C unless otherwise specified

Symbol	Output Voltage		5V			12V			15V			Units	
	Input Voltage (unless otherwise noted)		10V			19V			23V				
	Parameter	Conditions	Min	Typ	Max	Min	Typ	Max	Min	Typ	Max		
V _O	Output Voltage	T _J = 25°C, 5 mA ≤ I _O ≤ 1A	4.8	5	5.2	11.5	12	12.5	14.4	15	15.6	V	
		P _D ≤ 15W, 5 mA ≤ I _O ≤ 1A	4.75		5.25	11.4		12.6	14.25		15.75	V	
		V _{MIN} ≤ V _{IN} ≤ V _{MAX}	(7.5 ≤ V _{IN} ≤ 20)			(14.5 ≤ V _{IN} ≤ 27)			(17.5 ≤ V _{IN} ≤ 30)			V	
ΔV _O	Line Regulation	I _O = 500 mA	T _J = 25°C	3	50	4	120	4	150			mV	
			ΔV _{IN}	(7 ≤ V _{IN} ≤ 25)			(14.5 ≤ V _{IN} ≤ 30)			(17.5 ≤ V _{IN} ≤ 30)			V
		0°C ≤ T _J ≤ +125°C	ΔV _{IN}	50			120			150			mV
			ΔV _{IN}	(8 ≤ V _{IN} ≤ 20)			(15 ≤ V _{IN} ≤ 27)			(18.5 ≤ V _{IN} ≤ 30)			V
		I _O ≤ 1A	T _J = 25°C	50			120			150			mV
			ΔV _{IN}	(7.5 ≤ V _{IN} ≤ 20)			(14.6 ≤ V _{IN} ≤ 27)			(17.7 ≤ V _{IN} ≤ 30)			V
ΔV _O	Load Regulation	T _J = 25°C	5 mA ≤ I _O ≤ 1.5A	10	50	12	120	12	150			mV	
			250 mA ≤ I _O ≤ 750 mA		25		60		75			mV	
		5 mA ≤ I _O ≤ 1A, 0°C ≤ T _J ≤ +125°C	50			120			150			mV	
I _Q	Quiescent Current	I _O ≤ 1A	T _J = 25°C	8			8			8			mA
			0°C ≤ T _J ≤ +125°C	8.5			8.5			8.5			mA
ΔI _Q	Quiescent Current Change	5 mA ≤ I _O ≤ 1A		0.5			0.5			0.5			mA
		T _J = 25°C, I _O ≤ 1A		1.0			1.0			1.0			mA

LM340 Electrical Characteristics (Note 4) (Continued)

0°C ≤ T_J ≤ +125°C unless otherwise specified

Symbol	Output Voltage		5V			12V			15V			Units
	Input Voltage (unless otherwise noted)		10V			19V			23V			
	Parameter	Conditions	Min	Typ	Max	Min	Typ	Max	Min	Typ	Max	
		V _{MIN} ≤ V _{IN} ≤ V _{MAX}	(7.5 ≤ V _{IN} ≤ 20)			(14.8 ≤ V _{IN} ≤ 27)			(17.9 ≤ V _{IN} ≤ 30)			V
		I _O ≤ 500 mA, 0°C ≤ T _J ≤ +125°C	1.0			1.0			1.0			mA
		V _{MIN} ≤ V _{IN} ≤ V _{MAX}	(7 ≤ V _{IN} ≤ 25)			(14.5 ≤ V _{IN} ≤ 30)			(17.5 ≤ V _{IN} ≤ 30)			V
V _N	Output Noise Voltage	T _A = 25°C, 10 Hz ≤ f ≤ 100 kHz	40			75			90			μV
$\frac{\Delta V_{IN}}{\Delta V_{OUT}}$	Ripple Rejection	I _O ≤ 1A, T _J = 25°C	62	80		55	72		54	70		dB
		f = 120 Hz	62			55			54			dB
		V _{MIN} ≤ V _{IN} ≤ V _{MAX}	(8 ≤ V _{IN} ≤ 18)			(15 ≤ V _{IN} ≤ 25)			(18.5 ≤ V _{IN} ≤ 28.5)			V
R _O	Dropout Voltage	T _J = 25°C, I _O = 1A	2.0			2.0			2.0			V
	Output Resistance	f = 1 kHz	8			18			19			mΩ
	Short-Circuit Current	T _J = 25°C	2.1			1.5			1.2			A
	Peak Output Current	T _J = 25°C	2.4			2.4			2.4			A
	Average TC of V _{OUT}	0°C ≤ T _J ≤ +125°C, I _O = 5 mA	-0.6			-1.5			-1.8			mV/°C
V _{IN}	Input Voltage Required to Maintain Line Regulation	T _J = 25°C, I _O ≤ 1A	7.5			14.6			17.7			V

Note 1: Absolute Maximum Ratings are limits beyond which damage to the device may occur. Operating Conditions are conditions under which the device functions but the specifications might not be guaranteed. For guaranteed specifications and test conditions see the Electrical Characteristics.

Note 2: The maximum allowable power dissipation at any ambient temperature is a function of the maximum junction temperature for operation (T_{JMAX} = 125°C or 150°C), the junction-to-ambient thermal resistance (θ_{JA}), and the ambient temperature (T_A). P_{DMAX} = (T_{JMAX} - T_A)/θ_{JA}. If this dissipation is exceeded, the die temperature will rise above T_{JMAX} and the electrical specifications do not apply. If the die temperature rises above 150°C, the device will go into thermal shutdown. For the TO-3 package (K, KC), the junction-to-ambient thermal resistance (θ_{JA}) is 39°C/W. When using a heatsink, θ_{JA} is the sum of the 4°C/W junction-to-case thermal resistance (θ_{JC}) of the TO-3 package and the case-to-ambient thermal resistance of the heatsink. For the TO-220 package (T), θ_{JA} is 54°C/W and θ_{JC} is 4°C/W. If SOT-223 is used, the junction-to-ambient thermal resistance is 174°C/W and can be reduced by a heatsink (see Applications Hints on heatsinking).

If the TO-263 package is used, the thermal resistance can be reduced by increasing the PC board copper area thermally connected to the package: Using 0.5 square inches of copper area, θ_{JA} is 50°C/W; with 1 square inch of copper area, θ_{JA} is 37°C/W; and with 1.6 or more inches of copper area, θ_{JA} is 32°C/W.

Note 3: ESD rating is based on the human body model, 100 pF discharged through 1.5 kΩ.

Note 4: All characteristics are measured with a 0.22 μF capacitor from input to ground and a 0.1 μF capacitor from output to ground. All characteristics except noise voltage and ripple rejection ratio are measured using pulse techniques (t_w ≤ 10 ms, duty cycle ≤ 5%). Output voltage changes due to changes in internal temperature must be taken into account separately.

Note 5: Military datasheets are available upon request. At the time of printing, the military datasheet specifications for the LM140K-5.0/883, LM140K-12/883, and LM140K-15/883 complied with the min and max limits for the respective versions of the LM140. The LM140H and LM140K may also be procured as JAN devices on slash sheet JM38510/107.

Physical Dimensions inches (millimeters) unless otherwise noted

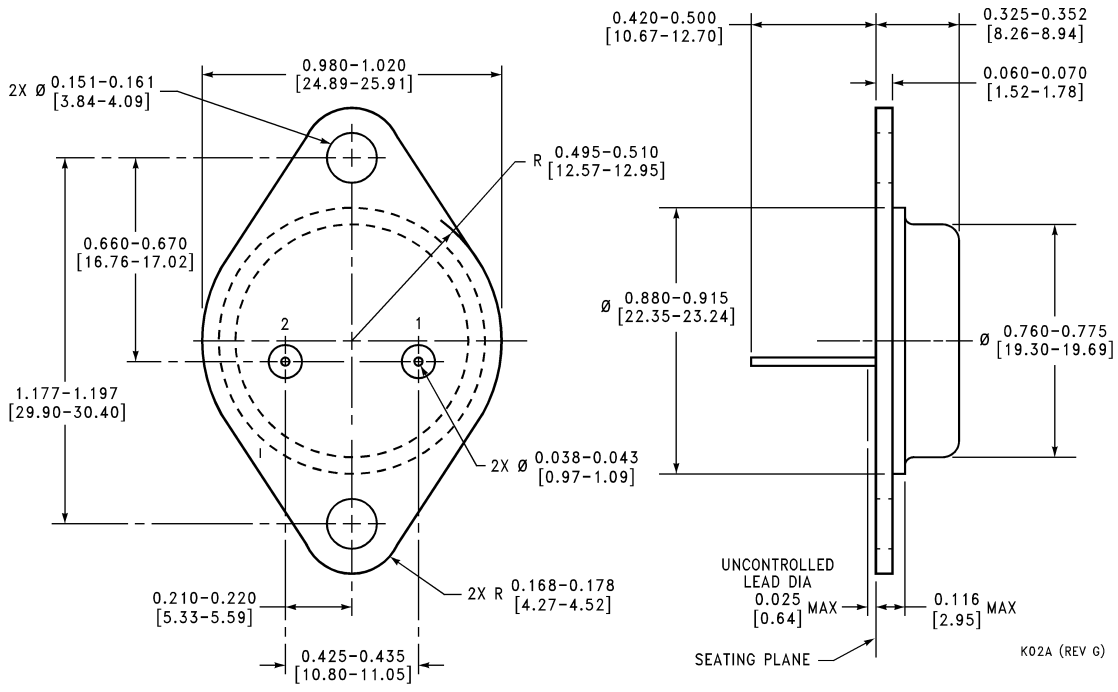

TO-3 Metal Can Package (K)
NS Package Number K02A

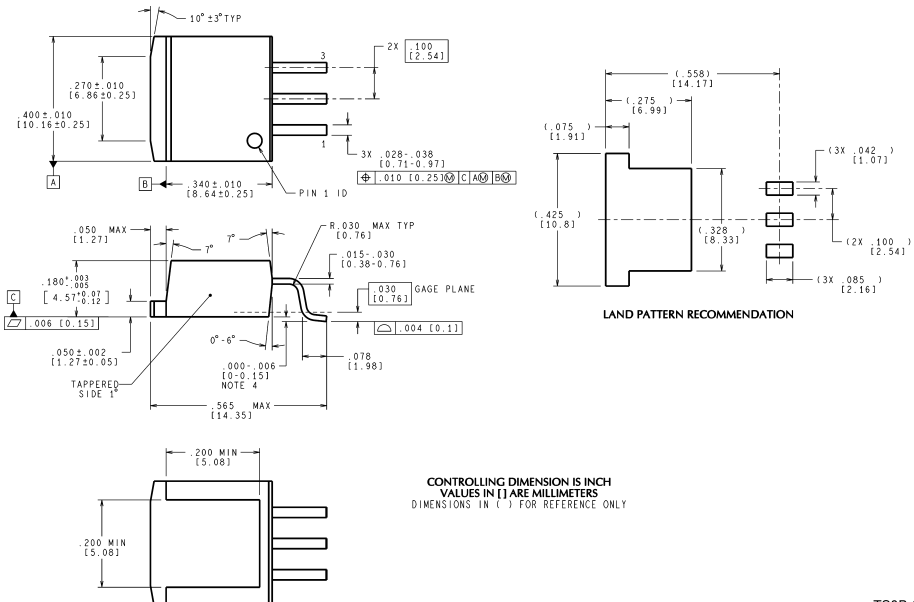

TO-263 Surface-Mount Package (S)
NS Package Number TS3B

TS3B (Rev F)

